

CIRCUIT PROTECTION



This Automotive Series
CIRCUIT PROTECTION
has been developed by

Kevin R. Sullivan

Professor of
Automotive Technology
Skyline College

All Rights Reserved

Visit us on the web: www.autoshop101.com

CIRCUIT PROTECTION

Circuit protection devices are used to protect wires and connectors from being damaged by excess current flow caused by an over current or short-circuit. Excess current causes excess heat, which causes circuit protection to "open circuit".

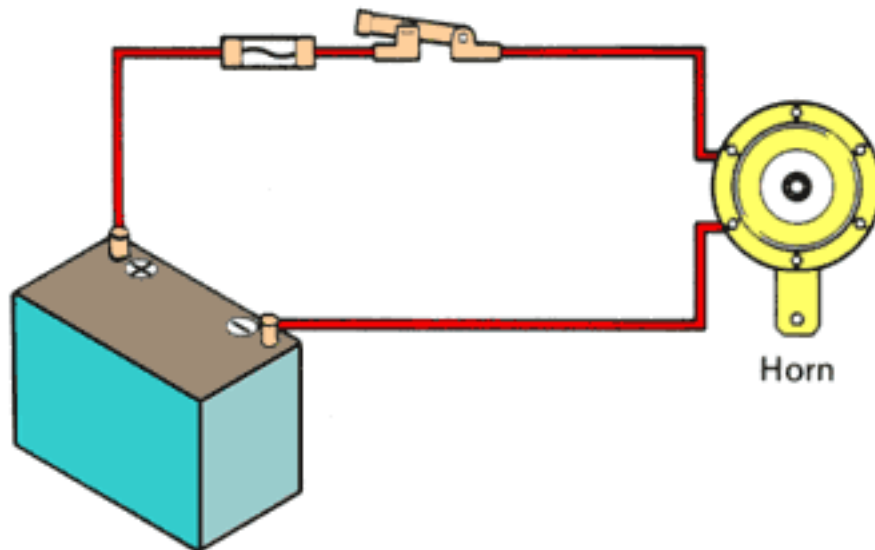

CIRCUIT PROTECTION

CIRCUIT PROTECTION DEVICES

Fuses, fuse elements, fusible links, and circuit breakers are used as circuit protection devices. Circuit protection devices are available in a variety of types, shapes, and specific current ratings.



FUSES

A fuse is the most common protection device. A fuse is placed in an electrical circuit, so that when current flow exceeds the rating of the fuse it "blows" or "blows out". The element in the fuse melts, opening the circuit and preventing other components of the circuit from being damaged by the overcurrent. The size of the metal fuse element determines the rating. Remember excessive current causes excess heat, and it's heat and not the current that causes the circuit protector to open. Once a fuse "blows" it must be replaced with a new one.

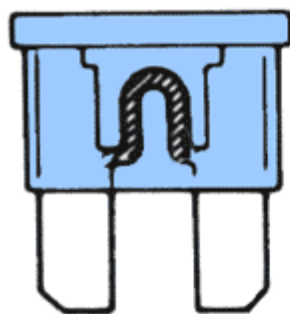

GOOD

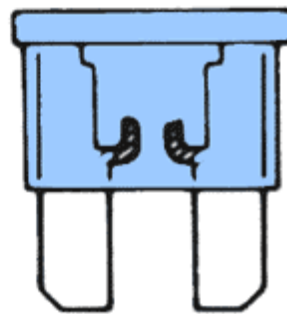

BLOWN

CIRCUIT PROTECTION

FUSE LOCATIONS

Fuses are located throughout the entire vehicle. Common locations include the engine compartment, behind the left or right kick panels, or under the dash. Fuses are usually grouped together and are often mixed in with other components like relays, circuit breakers, and fuse elements.



FUSE BLOCK COVERS

Fuse / relay block covers usually label the location and position of each fuse, relay, and fuse element contained within.



CIRCUIT PROTECTION

FUSE TYPES

Fuses are classified into basic categories: blade type fuses or cartridge type fuses. Several variations of each are used.

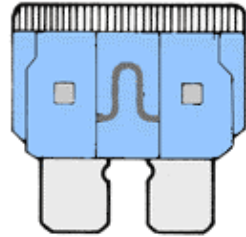

BLADE TYPE FUSE

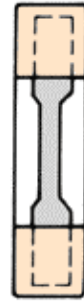

CARTRIDGE

COMMON FUSE TYPES

The blade fuse and fuse element are by far the most commonly used today. Three different types of blade fuses exist: The Maxi Fuse, The Standard ATO fuse, and the Mini fuse. The fuse element has replaced the fusible link and will be explained later.

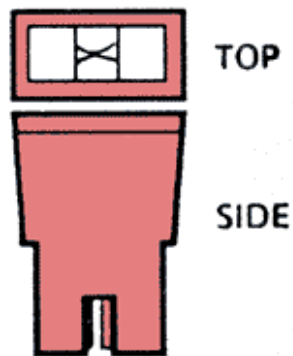

Fuse Element

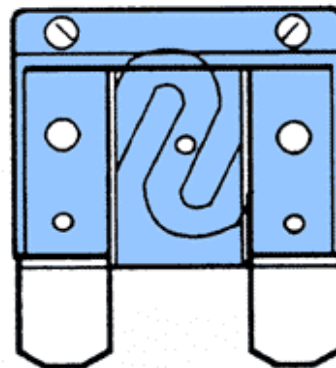

Maxifuse



Autofuse

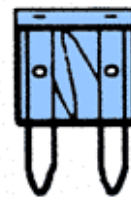

Minifuse

CIRCUIT PROTECTION

BASIC CONSTRUCTION

The blade type fuse is a compact design with a metal element and transparent insulating housing which is color-coded for each current rating. (Standard ATO shown below: however construction of both the mini and maxi fuses are the same.)

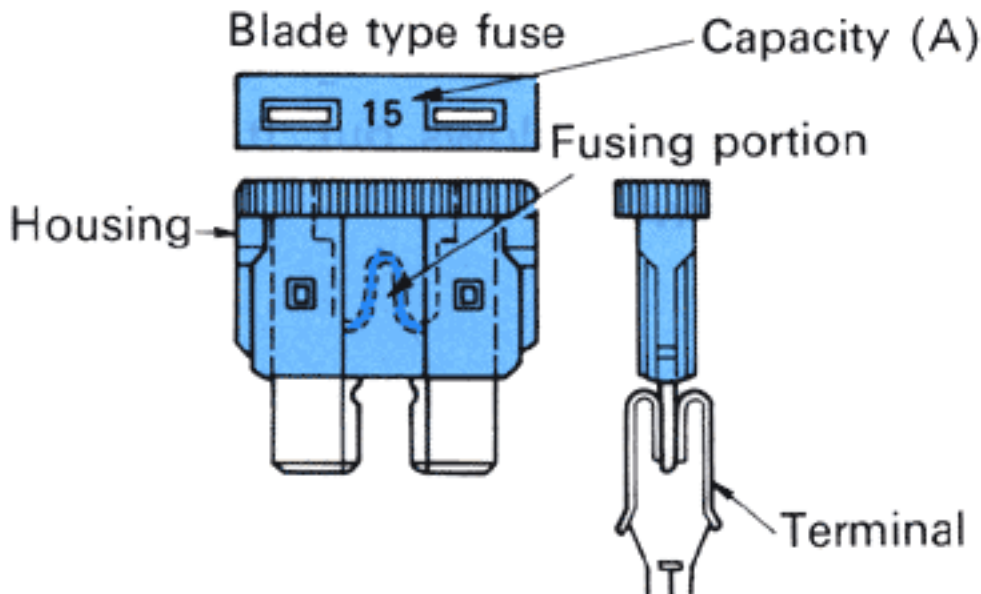

FUSE AMPERAGE COLOR RATING

Fuse amperage color ratings for both the mini and standard ATO fuses are identical. However, the amperage color ratings of maxi fuses use a different color scheme.

Color Ratings For STANDARD and MINI Fuses	
Fuse Amp Rating	Identification Color
3	Violet
5	Tan
7.5	Brown
10	Red
15	Blue
20	Yellow
25	Colorless
30	Green

CIRCUIT PROTECTION



MAXI	STANDARD	MINI
Color Ratings For MAXI Fuses		
Fuse Amp Rating	Identification Color	
20	Yellow	
30	Green	
40	Amber	
50	Red	
60	Blue	
70	Brown	
80	Colorless	

CIRCUIT PROTECTION

OLDER TYPE FUSES

Many older vehicles, both foreign and domestic, use glass or ceramic fuse cartridges that were either color coded or stamped on case for current ratings. Glass fuses were used on older domestic vehicles while the ceramic were used on most older European vehicles. Ceramic fuses have an amperage color rating system while glass fuses have the amperage ratings stamped into one of the metal end caps.



FUSIBLE LINKS AND FUSE ELEMENTS

Fusible links are divided into two categories: the fuse element cartridge and the fusible link. The construction and function of fusible links and fuse elements are similar to that of a fuse. The main difference is that the fusible link and fuse element are used to protect higher amperage electrical circuits, generally circuits 30 amps or higher. As with fuses, once a fusible link or fuse element blows out, it must be replaced with a new one.

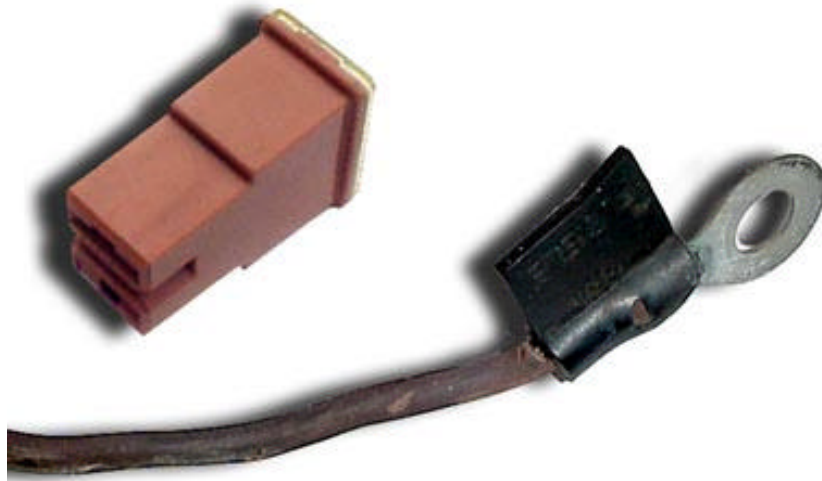

CIRCUIT PROTECTION

FUSE ELEMENT CARTRIDGE

Fuse elements, a cartridge type fusible link, are also known as a Pacific fuses. The element has the terminal and fusing portion as a unit. Fuse elements have replaced fusible links for the most part. The housing is color coded for each current rating. Although, fuse elements are available in two physical sizes and are either plug in or bolt on design, the plug-in type is the most popular.



FUSE ELEMENT CARTRIDGE CONSTRUCTION

Construction of the fuse element is quite simple. A colored plastic housing contains the fusing portion element which can be viewed through a clear top. Fuse ratings are also stamped on the case.

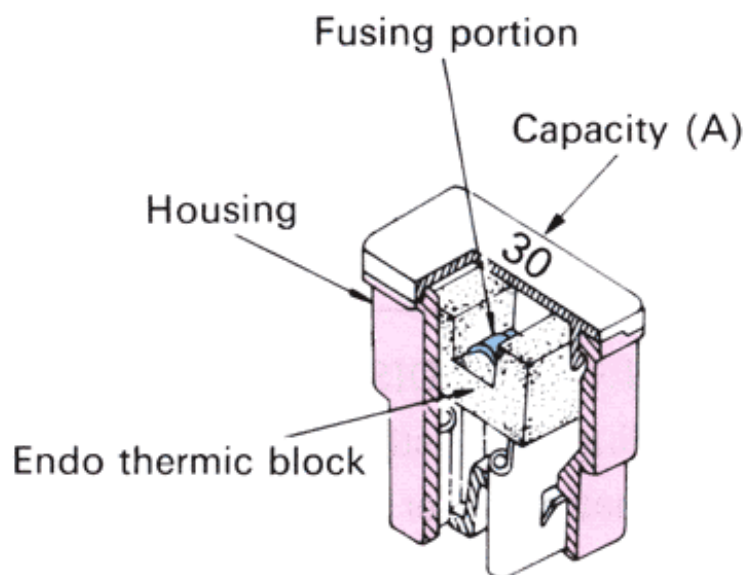

CIRCUIT PROTECTION

FUSE ELEMENT COLOR IDENTIFICATION

Fuse amperage color ratings are shown below. The fusing portion of the fuse element is visible through a clear window. The amperage ratings are also listed on the fuse element.



Fuse Element Color Ratings - Pacific	
Amperage Rating	Identification Color
30	Pink
40	Green
50	Red
60	Yellow
80	Black
100	Blue

CIRCUIT PROTECTION

FUSIBLE ELEMENTS

Fusible elements are often located near the battery by themselves.

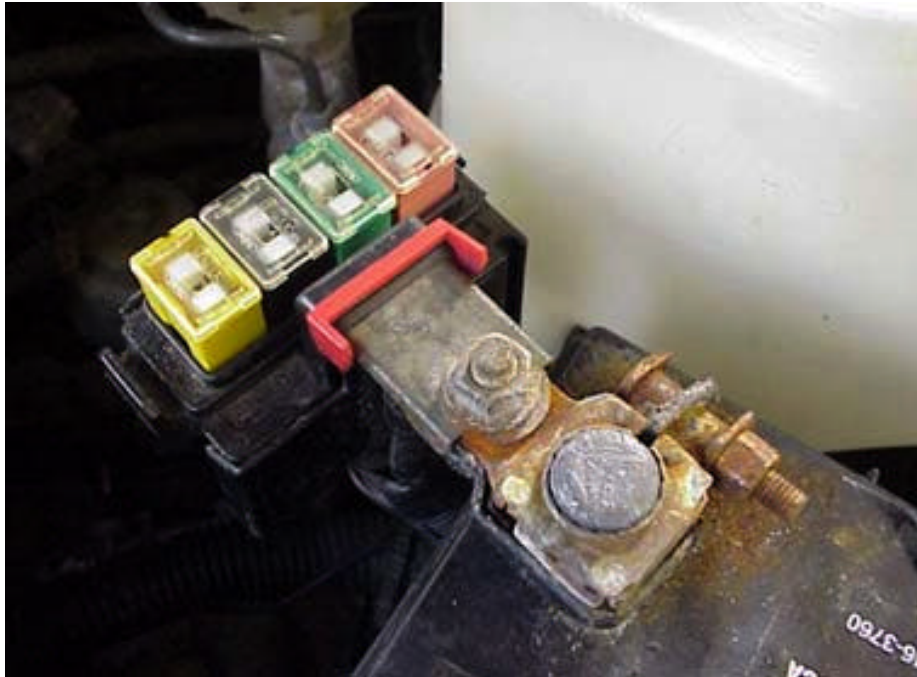

FUSIBLE ELEMENTS

Fusible elements can also be located in relay / fuse boxes in the engine compartment.



CIRCUIT PROTECTION

FUSIBLE LINKS

Fusible links are short pieces of a smaller diameter wire designed to melt during an over current condition. A fusible link is usually four (4) wire sizes smaller than the circuit that it is protecting. The insulation of a fusible link is a special nonflammable material. This allows the wire to melt, but the insulation to remain intact for safety. Some fusible links have a tag at one end that indicates its rating. Like fuses, fusible links must be replaced after they have "blown" or melted opened. Many manufacturers have replaced fusible links with fuse elements or maxi fuses.



CIRCUIT BREAKERS

Circuit breakers are used in place of fuses for the protection of complicated power circuits such as the power windows, sunroofs and heater circuits. Three types of circuit breakers exist: The manual reset type - mechanical, the automatic resetting type - mechanical, and the automatically reset solid state type - PTC. Circuit breakers are usually located in relay/fuse boxes; however, some components like power window motors have circuit breakers built in.



CIRCUIT PROTECTION

CIRCUIT BREAKER CONSTRUCTION (MANUAL TYPE)

A circuit breaker basically consists of a bimetal strip connected to two terminals and to a contact in between. Manual circuit breaker when tripped (current flow beyond its rating) will open and must be reset manually. These manual circuit breakers are called "non-cycling" circuit breakers.

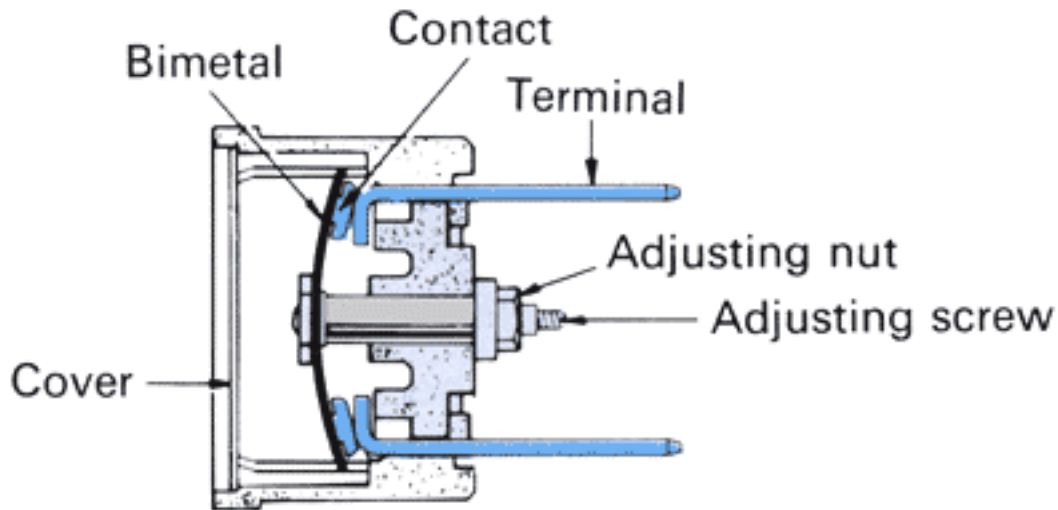

CIRCUIT BREAKER OPERATION (MANUAL TYPE)

The circuit breaker contains a metal strip made of two different metals bonded together called a bimetal strip. This strip is in the shape of a disc and is concaved downward. When heat from the excessive current is higher than the circuit breaker current rating the two metals change shape unevenly. The strip bends or warps upwards and the contacts open to stop current flow. The circuit breaker can be reset after it is tripped.

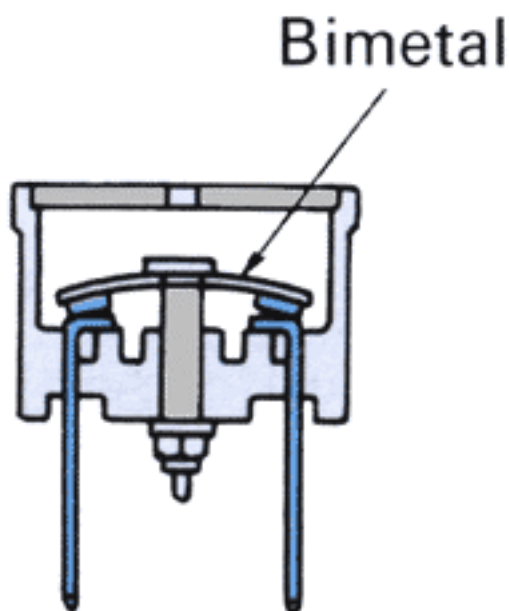

CIRCUIT PROTECTION

MANUAL RESET TYPE

When a circuit breaker is opened by an over-current condition, the circuit breaker requires reset. To do so, insert a small rod (paper clip) to reset the bimetal plate as shown below.

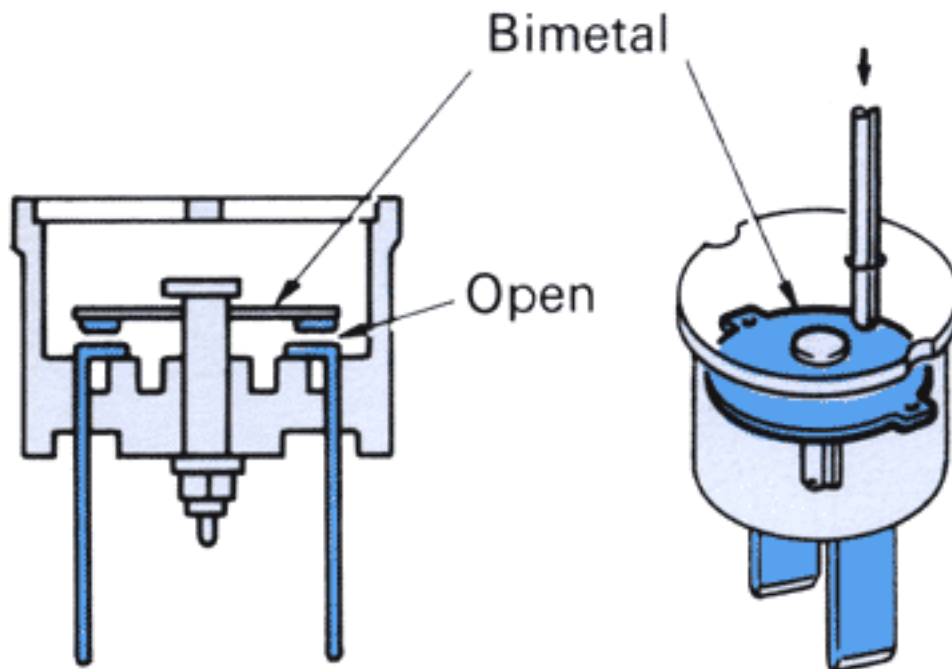

AUTOMATIC RESETTING TYPE - MECHANICAL

Circuit breakers that automatically reset are called "cycling" circuit breakers. This type of circuit breaker is used to protect high current circuits, such as power door locks, power windows, air conditioning, etc. The automatically resetting circuit breaker contains a bimetal strip. The bimetal strip will overheat and open from the excess current by an overcurrent condition and is automatically reset when the temperature of the bimetal strip cools.



CIRCUIT PROTECTION

AUTO RESET CONSTRUCTION AND OPERATION

A cycling circuit breaker contains a metal strip made of two different metals bonded together called a bimetal strip. When heat from the excessive current is higher than the circuit breaker current rating the two metals change shape unevenly. The strip bends upwards and a set of contacts open to stop current flow. With no current flowing the bimetal strip cools and returns to its normal shape, closing the contacts and resuming the current flow. Automatically resetting circuit breakers are said to "cycle" because they cycle open and closed until the current returns to a normal level.

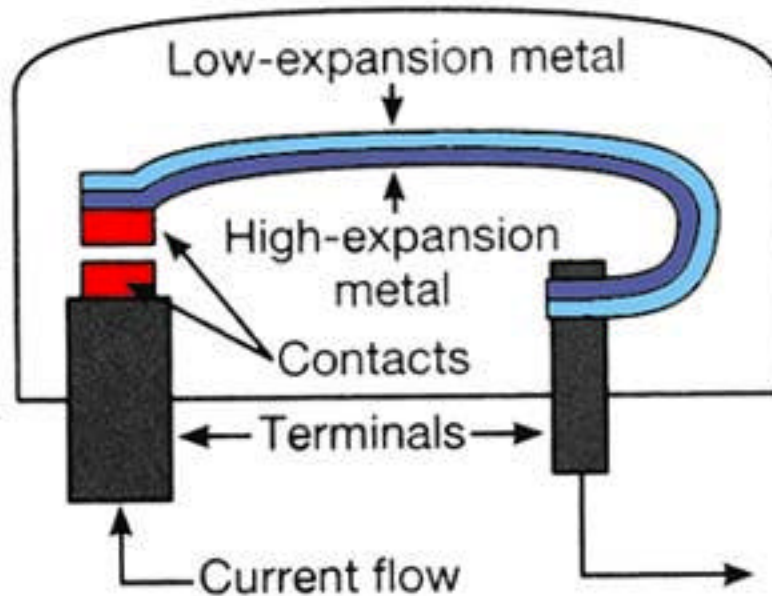

CIRCUIT PROTECTION

AUTOMATIC RESETTING SOLID STATE TYPE - PTC

A Polymer PTC (for Positive Temperature Coefficient) is a special type of circuit breaker called a thermistor (or thermal resistor). A PTC thermistor increases resistance as its temperature is increased. PTCs, which are made from a conductive polymer, are solid state devices, which means they have no moving parts. PTCs are commonly used to protect power window and power door lock circuits.

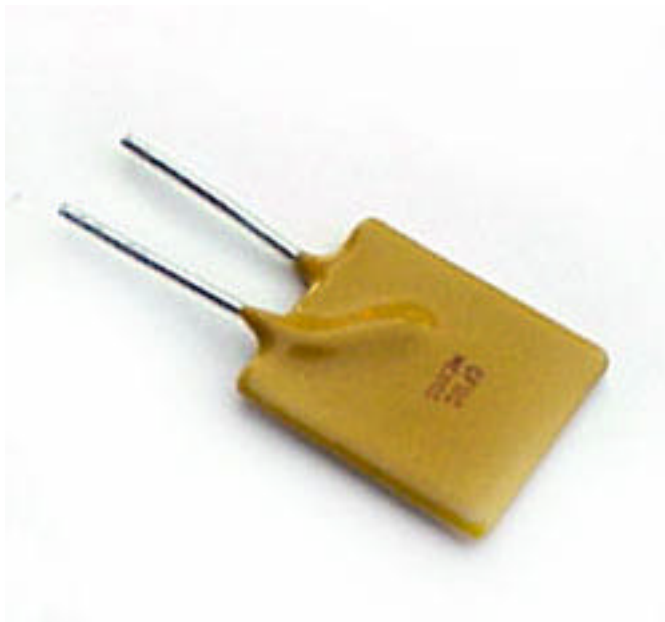

POLYMER PTC CONSTRUCTION AND OPERATION

In its normal state, the material in a polymer PTC is in the form of a dense crystal, with many carbon particles packed together. The carbon particles provide conductive pathways for current flow. This resistance is low. When the material is heated from excessive current, the polymer expands, pulling the carbon chains apart. In this expanded "tripped" state, there are few pathways for current. When current flow exceeds the trip threshold, the device remains in the "open circuit" state as long as voltage remains applied to the circuit. It resets only when voltage is removed and the polymer cools. PTCs are used to protect power window and power door lock circuits.

NORMAL STATE



TRIPPED STATE

